

# Verkoopssystemen Systèmes de vente

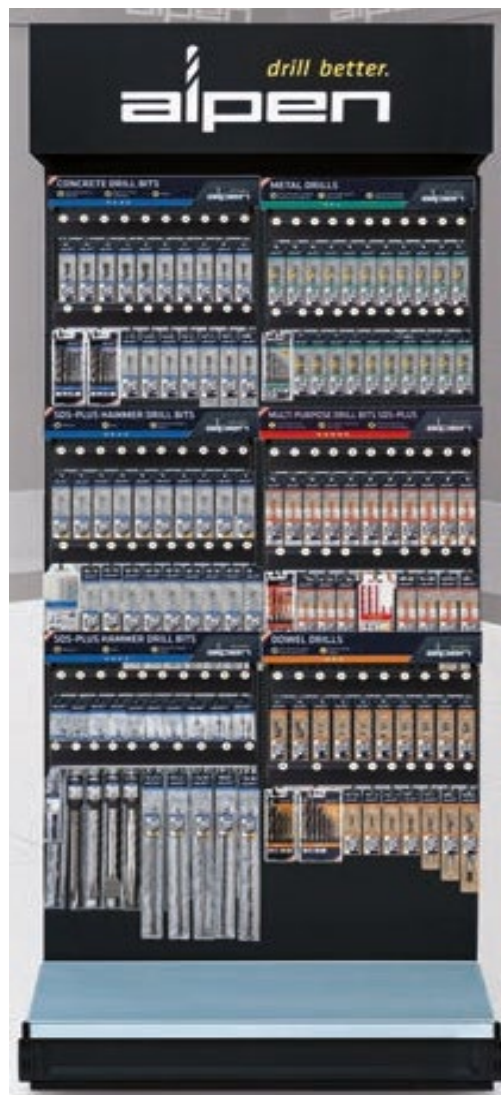

**De juiste verkoopsystemen voor elke ruimte: van toonbankdisplays tot en met complete presentatiewanden.**

**Les systèmes de vente appropriés pour chaque espace : des présentoirs de comptoir jusqu'à des murs de présentation complets.**



**Verschillende modulen beschikbaar**

**Différents modules disponibles**



**Wij sturen u graag een aangepaste offerte op maat van uw behoeften.**

**Nous nous ferons un plaisir de vous faire parvenir une offre spécialement adaptée à vos besoins.**

**Scharfe Schneiden**

auch bei größeren Durchmessern wenig Vorschubdruck erforderlich

**Sharp cutting edges**

even with larger diameters little feed pressure is required

**Filos bien afilados**

Con diámetros más grandes, se necesita menos presión de avance

**Sehr hohe Elastizität**

und höchste Zähigkeit bei optimaler Schneidleistung

**Very high elasticity**

and greatest toughness with optimum cutting performance

**Elasticidad muy elevada**

y la mayor resistencia con una capacidad óptima de corte

**Hohe Bruchstabilität**

auch bei kleineren Durchmessern geringe Bruchgefahr durch hohe Elastizität

**High fracture resistance**

even with smaller diameters low risk of breakage due to high elasticity

**Gran resistencia a la rotura**

Con diámetros más pequeños, existe un riesgo menor de rotura debido a la gran elasticidad

**Optimale Bohrleistung**

auch bei ungünstigen Arbeitsbedingungen

**Optimum drilling performance**

even in unfavourable working conditions

**Capacidad de perforación óptima**

incluso en condiciones de trabajo desfavorables



## Cardboard Display "Sprint Master"



Ref.	Bar code EAN13	Artikel-Article	
34A098000831		Display 15 cassettes 6 st/pcs Ø 2,0-3,0-4,0-5,0-6,0-8,0 mm	1



Ref.	Bar code EAN13	Artikel-Article	Inh-Cont.	
34A008111221	9002741208524	Cassettes Ø 2,0-3,0-4,0-5,0-6,0-8,0 mm	1	10

# Sprint MASTER Metaal boor Mèches Métal



Ref.	Ø mm	l1 mm	l2 mm	Bar code EAN13	Inh-Cont.	
34A618002001	2,00	49	24	9002741208616	3	10
34A618002501	2,50	57	30	9002741208623	3	10
34A618003001	3,00	61	33	9002741208630	3	10
34A618003201	3,20	65	36	9002741208647	3	10
34A618003501	3,50	70	39	9002741208661	2	10
34A618004001	4,00	75	43	9002741208678	2	10
34A618004201	4,20	75	43	9002741208685	2	10
34A918004501	4,50	80	47	9002741208692	2	10
34A618005001	5,00	86	52	9002741208715	2	10
34A618005501	5,50	93	57	9002741208722	2	10
34A618006001	6,00	93	57	9002741208739	2	10
34A618006501	6,50	101	63	9002741208746	1	10
34A618007001	7,00	109	69	9002741208760	1	10
34A618008001	8,00	117	75	9002741208784	1	10
34A618008501	8,50	117	75	9002741208791	1	10
34A618009001	9,00	125	81	9002741208807	1	10
34A618010001	10,00	133	87	9002741208821	1	10
34A618012001	12,00	151	101	9002741208876	1	10
34A618013001	13,00	151	101	9002741208890	1	10



HSS Boor met gereduceerde staart Ø 9,5

HSS Mèche avec queue réduite Ø 9,5

Ref.	Ø mm	l1 mm	l2 mm	Bar code EAN13	Inh-Cont.	
34A640012501	12,50	151	101	9002741211852	1	10
34A640014001	14,00	160	108	9002741211753	1	8
34A640014501	14,50	169	114	9002741211883	1	8
34A640016001	16,00	178	120	9002741211746	1	8

# C PROTECTOR

Tegels-Faeince-Harde Porselein / Carrelage-Faïence-Porcelaine dure



Ref.	∅ mm	l1 mm	Bar code EAN13	Inh-Cont.	
34A303005001	5,00	105	9002741293841	1	10
34A303006001	6,00	115	9002741293858	1	10
34A303008001	8,00	120	9002741293865	1	10
34A303010001	10,00	120	9002741293872	1	10
34A303012001	12,00	120	9002741293889	1	10



+ Profi Beton



Ref.	∅ mm	l1 mm	Bar code EAN13	Inh-Cont.	
34A003030521	5,00	105	9002741294381	2	10
34A003000621	6,00	115	9002741294398	2	10
34A003000821	8,00	120	9002741294428	2	10
34A003001021	10,00	120	9002741294435	2	10

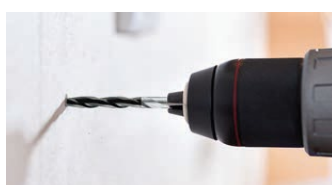

## Cardboard Display

34A098001671	Display 5st/pcs ∅6-∅8-∅10	Tot.15 st/pcs	1
--------------	---------------------------	---------------	---



# Boor voor tegels, faience, glas, rode steen Mèche pour carrelage, faïence, verre, brique rouge

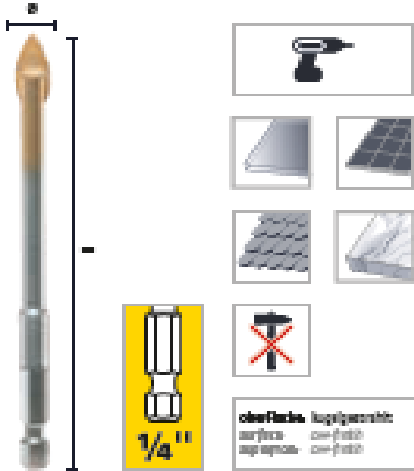

**Tungsten Carbide**

Ref.	Ø mm	l1 mm	Bar code EAN13	Inh-Cont.	
34A411020	5,00	105	3509094110208	1	10
34A411030	6,00	105	3509094110307	1	10
34A411050	8,00	110	3509094110604	1	10
34A411060	10,00	130	3509094110604	1	10

## Nieuwe referenties - Nouvelle références

Ref.	Ø mm	l1 mm	Bar code EAN13	Inh-Cont.	
34A289003001	3,00	100	9002740230106	1	10
34A289004001	4,00	100	9002740230113	1	10
34A289005001	5,00	105	9002740230120	1	10
34A289006001	6,00	105	9002740230137	1	10
34A289008001	8,00	110	9002740230144	1	10
34A289010001	10,00	110	9002740230151	1	10

Ref.	Ø mm	Bar code EAN13	Inh-Cont.		
34A289000031	5,0-6,0-8,0	3 st/pcs	9002741165568	1	5



# TC Ceramic

**Hoog rendement boor voor het boren van tegels, keramiek en marmer.**

**Alleen roterend.**

**Mèche à haute efficacité pour le perçage des Carrelages, céramique et marbre.**

**Rotatif seulement.**

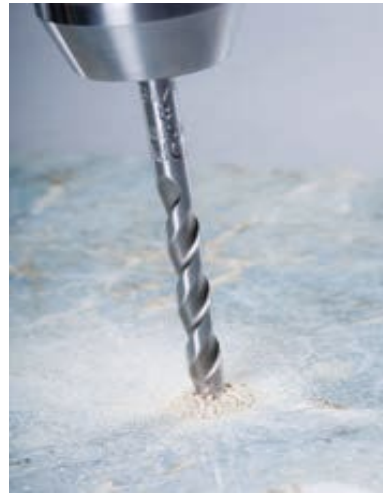
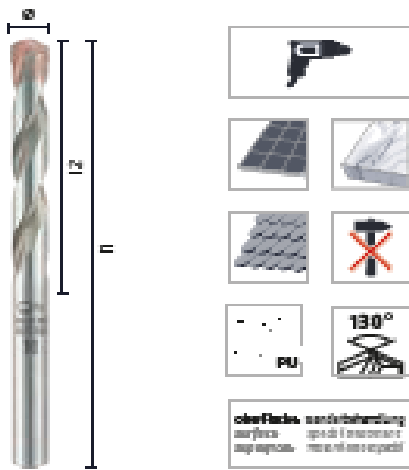

## Tungsten Carbide

Ref.	Ø mm	l1 mm	l2 mm	Bar code EAN13	Inh-Cont.	
34A297004001	4,00	75	39	9002740230304	1	10
34A297005001	5,00	85	39	9002740230311	1	10
34A297006001	6,00	100	54	9002740230335	1	10
34A297006501	6,50	100	54	9002740342441	1	10
34A297008001	8,00	120	80	9002740230359	1	10
34A297010001	10,00	120	80	9002740230366	1	10
34A297012001	12,00	150	90	9002740230373	1	10
34A297014001	14,00	150	90	9002740230380	1	10



**Diamant tegel boor met sjabloon en water koeling systeem  
Voor harde ceramiek tegels,marmer,graniet,porselein**

**Foret diamanté avec insert et réservoir d'eau pour refroidissement  
Pour carrelage en céramique dure, marbre, granit, porcelaine**



**Geschikt voor elke accuboormachine. Niet geschikt voor het boren met percussie.  
Waterkoeling noodzakelijk**

**Convient à toutes les perceuse sans fil. Ne convient pas pour le forage à percussion.  
Refroidissement par eau nécessaire.**

Ref.	∅ mm	l1 mm	Bar code EAN13	
34A290600	6	60	9002740900955	1
34A290800	8	60	9002740900962	1
34A291000	10	60	9002740900979	1
34A291200	12	60	9002740900993	1
34A291500	15	60	9002740901006	1

**De all-rounder Steen-hout-plastiek-blauwsteen-ceramiek  
carbide punt,extra scherpe snijkanten dus ook geschikt voor metaal.**

## PROFI MULTICUT



### Der Allesstönner

*The all-rounder  
Il tuttofare*

### Hartmetallplatte

Extra scharfe Schneiden, deshalb  
bestens auch für Metall geeignet

### Carbide tip

Extra sharp cutting edges, so very  
well suited for metal too

### Placchetta in Metallo Duro

taglien ti super affilati e quindi idonei  
anche alla foratura di metallo

### Patentiertes 4-fach Stufenprofil

Schnelle Bohrmehlförderung beim  
Bohren in Mauerwerk und Beton

### Patented 4-step profile

Fast drill dust feed when drilling in to  
masonry and concrete

### Profilo brevettato a 4 fasi

veloce evacuazione delle polveri dur-  
ante la foratura in muro e cemento

### Verschiedene Längen

bis zu 400 mm verfügbar

### Various lengths

up to 400 mm available

### Diverse lunghezze

disponibile fino a 400 mm

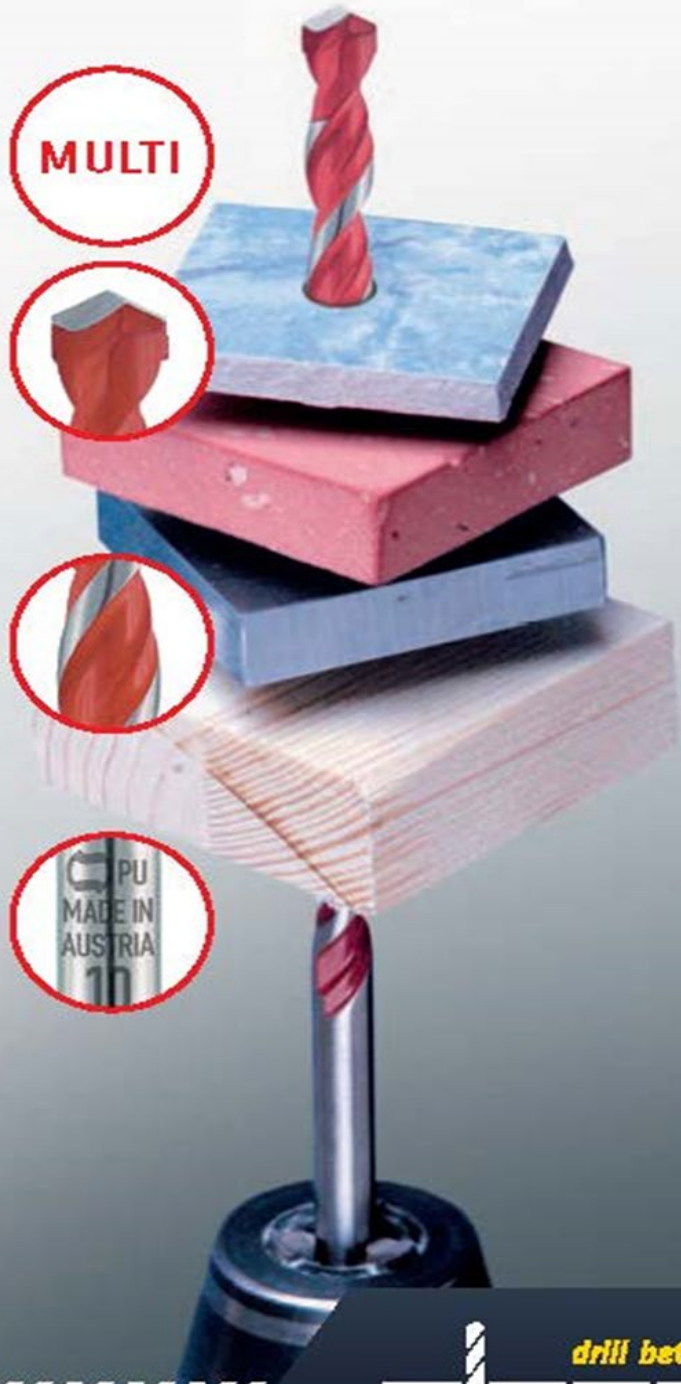

**alpen** *drill better.*

**Le all-rounder Pierre-bois-plastique(PVC)-pierre bleu-céramique  
Pointe carbide,extra tranchants,très adapté pour le métal .**

# Profi Multicut



Ref.	Ø mm	l1 mm	l2 mm	Bar code EAN13	Inh-Cont.	
34A172003001	3,00	60	30	9002741152070	1	10
34A172004001	4,00	75	39	9002740008101	1	10
34A172005001	5,00	85	39	9002740008118	1	10
34A172005501	5,50	85	39	9002740008125	1	10
34A172006001	6,00	100	54	9002740008132	1	10
34A172006501	6,50	100	54	9002740008149	1	10
34A172007001	7,00	100	54	9002740008156	1	10
34A172008001	8,00	120	80	9002740008163	1	10
34A172010001	10,00	120	80	9002740008170	1	10
34A172012001	12,00	150	90	9002741152087	1	10

## Lengte-Longueur 150/85 mm & 200/135mm

Ref.	Ø mm	l1 mm	l2 mm	Bar code EAN13	Inh-Cont.	
34A729005001	5,00	150	85	9002740000235	1	10
34A729005501	5,50	150	85	9002740006770	1	10
34A729006001	6,00	200	135	9002740000242	1	10
34A729006501	6,50	200	135	9002740006787	1	10
34A729007001	7,00	200	135	9002740006794	1	10
34A729008001	8,00	200	135	9002740000259	1	10
34A729010001	10,00	200	135	9002740000280	1	10
34A729012001	12,00	220	150	9002740000266	1	10
34A729014001	14,00	220	150	9002740000273	1	10

## Lengte-Longueur 400/300 mm

Ref.	Ø mm	l1 mm	l2 mm	Bar code EAN13	Inh-Cont.	
34A730005001	5,00	400	300	9002741210206	1	10
34A730005501	5,50	400	300	9002741210190	1	10
34A730006001	6,00	400	300	9002741045921	1	10
34A730006501	6,50	400	300	9002741045938	1	10
34A730008001	8,00	400	300	9002741045945	1	10
34A730010001	10,00	400	300	9002741045952	1	10
34A730012001	12,00	400	300	9002741045969	1	10
34A730014001	14,00	400	300	9002741045976	1	10
34A730016001	16,00	400	300	9002741045983	1	10



# Profi Multicut

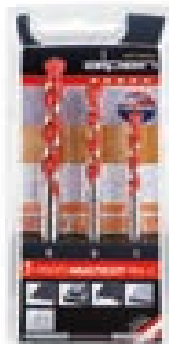

Ref.	Ø mm		Bar code EAN13	Inh-Cont.	
34A001007031	5,0-6,0-8,0	3 st/pcs	9002741123346	1	5



Ref.	Ø mm		Bar code EAN13	Inh-Cont.	
34A001007051	4,0-5,0-6,0-8,0-10,0	5st/pcs	9002741011346	1	5



## Profi Multicut SDS+

### Special SDS+ staaf met Hamer Stop functie Tige Spécial SDS+ Avec arrêt de Percussion

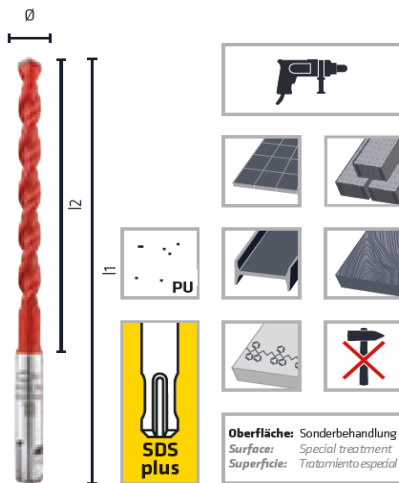

Automatische  
Schlag-Stopp-Funktion  
*Automatic  
hammer-stop function  
Función automática  
de parada de percusión*



#### Lengte-Longueur 110/50mm

Ref.	Ø mm	l1 mm	l2 mm	Bar code EAN13	Inh-Cont.	
34A509004001	4,00	110	50	9002741263882	1	10
34A509005001	5,00	110	50	9002741150977	1	10
34A509006001	6,00	110	50	9002741150984	1	10
34A509008001	8,00	110	50	9002741150991	1	10

#### Lengte-Longueur 160/100mm

Ref.	Ø mm	l1 mm	l2 mm	Bar code EAN13	Inh-Cont.	
34A519005001	5,00	160	100	9002741263899	1	10
34A519006001	6,00	160	100	9002741151004	1	10
34A519007001	7,00	160	100	9002741263905	1	10
34A519008001	8,00	160	100	9002741151011	1	10
34A519010001	10,00	160	100	9002741151028	1	10
34A519012001	12,00	160	100	9002741172337	1	10
34A519014001	14,00	160	100	9002741172344	1	10

#### Lengte-Longueur 210/150mm

Ref.	Ø mm	l1 mm	l2 mm	Bar code EAN13	Inh-Cont.	
34A529006001	6,00	210	150	9002741172351	1	10
34A529008001	8,00	210	150	9002741151035	1	10
34A529010001	10,00	210	150	9002741151042	1	10
34A529012001	12,00	210	150	9002741151059	1	10
34A529014001	14,00	210	150	9002741172368	1	10



### Lengte-Longueur 260/200mm

Ref.	Ø mm	l1 mm	l2 mm	Bar code EAN13	Inh-Cont.	
34A539006001	6,00	260	200	9002741163366	1	10
34A539006501	6,50	260	200	9002741161218	1	10
34A539008001	8,00	260	200	9002741161225	1	10
34A539010001	10,00	260	200	9002741161232	1	10
34A539012001	12,00	260	200	9002741161249	1	10
34A539014001	14,00	260	200	9002741163359	1	10
34A539016001	16,00	260	200	9002741163342	1	10



### Lengte-Longueur 450/400mm

### Nieuw-Nouveaux lengte/longueur 450mm

Ref.	Ø mm	l1 mm	l2 mm	Bar code EAN13	Inh-Cont.	
34A579006501	6,50	450	400	9002741268740	1	5
34A579008001	8,00	450	400	9002741236671	1	5
34A579010001	10,00	450	400	9002741192427	1	5
34A579012001	12,00	450	400	9002741240364	1	5
34A579014001	14,00	450	400	9002741240371	1	5
34A579016001	16,00	450	400	9002741240357	1	5
34A579018001	18,00	450	400	9002741240340	1	5
34A579020001	20,00	450	400	9002741240333	1	5



34A579000041				9002741263813		1
--------------	--	--	--	---------------	--	---

**Set/Box 4 st/pcs Ø 8.0-10.0-12.0-16.0  
Lengte-Longueur 450mm**



Ref.	Ø mm	Bar code EAN13	Inh-Cont.	
34A001009051	5,0-6,0x110mm-6,0-8,0-10,0x160mm 5 st/pcs	9002741156368	1	5



**F4 FORTE**



**Patentierter Hartmetallplatte**  
mit exzellenten Zentriereigen-  
schaften

*Patented carbide tip*  
with excellent centering properties

*Plancha de metal duro patentada*  
con excelentes propiedades de  
centrado

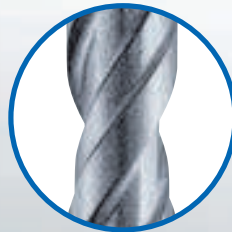

**Patentiertes 4-fach Stufenprofil**  
für schnelle Bohrmehlförderung

*Patented 4-step profile*  
for fast drill dust feed

*Perfil cuádruple escalonado paten-  
tado*  
para la eliminación rápida  
de los detritos.

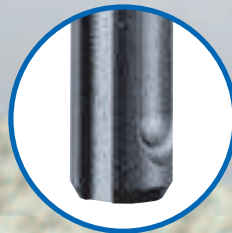

*drill better.*  
**alpen**

# Boren SDS+ Mèches SDS+



## Lengte-Longueur 110/50 mm

Ref.	Ø mm	l1 mm	l2 mm	Bar code EAN13	Inh-Cont.	
34A807004001	4,00	110	50	9002740234340	1	10
34A807005001	5,00	110	50	9002740234364	1	10
34A807005501	5,50	110	50	9002740234371	1	10
34A807006001	6,00	110	50	9002740234388	1	10
34A807006501	6,50	110	50	9002740234401	1	10
34A807007001	7,00	110	50	9002740234418	1	10
34A807008001	8,00	110	50	9002740234432	1	10
34A807010001	10,00	110	50	9002740234449	1	10

## Lengte-Longueur 160/100 mm

Ref.	Ø mm	l1 mm	l2 mm	Bar code EAN13	Inh-Cont.	
34A817004001	4,00	160	100	9002740661498	1	10
34A817005001	5,00	160	100	9002740234494	1	10
34A817005501	5,50	160	100	9002740234500	1	10
34A817006001	6,00	160	100	9002740234517	1	10
34A817006501	6,50	160	100	9002740234531	1	10
34A817007001	7,00	160	100	9002740234548	1	10
34A817008001	8,00	160	100	9002740234579	1	10
34A817009001	9,00	160	100	9002740385769	1	10
34A817009501	9,50	160	100	9002740579373	1	10
34A817010001	10,00	160	100	9002740234593	1	10
34A817011001	11,00	160	100	9002740234609	1	10
34A817012001	12,00	160	100	9002740234623	1	10
34A817013001	13,00	160	100	9002740234647	1	10
34A817014001	14,00	160	100	9002740234654	1	10
34A817015001	15,00	160	100	9002740234678	1	10
34A817016001	16,00	160	100	9002740277637	1	10





## Lengte-Longueur 210/150 mm

Ref.	Ø mm	l1 mm	l2 mm	Bar code EAN13	Inh-Cont.	
34A827005001	5,00	210	150	9002740601364	1	8
34A827005501	5,50	210	150	9002740632696	1	8
34A827006001	6,00	210	150	9002740350385	1	8
34A827006501	6,50	210	150	9002740567431	1	8
34A827007001	7,00	210	150	9002740418238	1	8
34A827008001	8,00	210	150	9002740234746	1	8
34A827009001	9,00	210	150	9002740234753	1	8
34A827010001	10,00	210	150	9002740234760	1	8
34A827012001	12,00	210	150	9002740234777	1	8
34A827014001	14,00	210	150	9002740234784	1	8
34A827015001	15,00	210	150	9002740404187	1	8
34A827016001	16,00	210	150	9002740234791	1	8
34A827017001	17,00	210	150	9002741109791	1	8
34A827018001	18,00	210	150	9002740235408	1	8
34A827019001	19,00	210	150	9002740235415	1	8
34A827020001	20,00	210	150	9002740235422	1	8

## Lengte-Longueur 260/200 mm

Ref.	Ø mm	l1 mm	l2 mm	Bar code EAN13	Inh-Cont.	
34A837005001	5,00	260	200	9002741133802	1	8
34A837005501	5,50	260	200	9002740980353	1	8
34A837006001	6,00	260	200	9002740351214	1	8
34A837006501	6,50	260	200	9002740593942	1	8
34A837007001	7,00	260	200	9002740978138	1	8
34A837008001	8,00	260	200	9002740234814	1	8
34A837010001	10,00	260	200	9002740234838	1	8
34A837011001	11,00	260	200	9002740234845	1	8
34A837012001	12,00	260	200	9002740234852	1	8
34A837013001	13,00	260	200	9002740234876	1	8
34A837014001	14,00	260	200	9002740234883	1	8
34A837015001	15,00	260	200	9002740234890	1	8
34A837016001	16,00	260	200	9002740234913	1	8
34A837018001	18,00	260	200	9002740418245	1	8
34A837020001	20,00	260	200	9002740418252	1	8
34A837022001	22,00	260	200	9002740235446	1	8
34A837024001	24,00	260	200	9002740235460	1	8
34A837025001	25,00	260	200	9002740235477	1	8
34A837026001	26,00	260	200	9002740235484	1	8



## Lengte-Longueur 310/250 mm

Ref.	∅ mm	l1 mm	l2 mm	Bar code EAN13	Inh-Cont.	
34A847005001	5,00	310	250	9002741051519	1	8
34A847005501	5,50	310	250	9002740980360	1	8
34A847006001	6,00	310	250	9002740588146	1	8
34A847006501	6,50	310	250	9002740980377	1	8
34A847007001	7,00	310	250	9002740685524	1	8
34A847008001	8,00	310	250	9002740587590	1	8
34A847010001	10,00	310	250	9002740234968	1	8
34A847012001	12,00	310	250	9002740346197	1	8
34A847013001	13,00	310	250	9002740352624	1	8
34A847014001	14,00	310	250	9002740235019	1	8
34A847016001	16,00	310	250	9002740235040	1	8
34A847018001	18,00	310	250	9002740319023	1	8
34A847019001	19,00	310	250	9002740593478	1	8
34A847020001	20,00	310	250	9002740235545	1	8
34A847022001	22,00	310	250	9002740418269	1	8
34A847024001	24,00	310	250	9002740418276	1	8
34A847025001	25,00	310	250	9002740632825	1	8

## Lengte-Longueur 450/400 mm

Ref.	∅ mm	l1 mm	l2 mm	Bar code EAN13	Inh-Cont.	
34A877005001	5,00	450	400	9002741051526	1	5
34A877005501	5,50	450	400	9002740980384	1	5
34A877006001	6,00	450	400	9002740682189	1	5
34A877006501	6,50	450	400	9002740980391	1	5
34A877008001	8,00	450	400	9002740402718	1	5
34A877010001	10,00	450	400	9002740235194	1	5
34A877012001	12,00	450	400	9002740235200	1	5
34A877013001	13,00	450	400	9002740544364	1	5
34A877014001	14,00	450	400	9002740235224	1	5
34A877015001	15,00	450	400	9002740235231	1	5
34A877016001	16,00	450	400	9002740235255	1	5
34A877018001	18,00	450	400	9002740235583	1	5
34A877019001	19,00	450	400	9002740613091	1	5
34A877020001	20,00	450	400	9002740235606	1	5
34A877022001	22,00	450	400	9002740235613	1	5
34A877024001	24,00	450	400	9002740384588	1	5
34A877025001	25,00	450	400	9002740235644	1	5
34A877026001	26,00	450	400	9002740235651	1	5



# Boren SDS+ Mèches SDS+



## Lengte-Longueur 600/550 mm

Ref.	Ø mm	l1 mm	l2 mm	Bar code EAN13	Inh-Cont.		H st/pcs
34A887010001	10,00	600	550	9002740534686	1	5	€ 36,00
34A887012001	12,00	600	550	9002740235293	1	5	€ 36,00
34A887014001	14,00	600	550	9002740235316	1	5	€ 40,45
34A887016001	16,00	600	550	9002740319030	1	5	€ 41,04
34A887018001	18,00	600	550	9002740561118	1	5	€ 62,81
34A887020001	20,00	600	550	9002740534709	1	5	€ 64,03
34A887024001	24,00	600	550	9002740536345	1	5	€ 89,08
34A887025001	25,00	600	550	9002740003540	1	5	€ 95,44

## Lengte-Longueur 800/740 mm

Ref.	Ø mm	l1 mm	l2 mm	Bar code EAN13	Inh-Cont.		st/pcs
34A913012001	12,00	800	740	9002740626657	1	1	€ 55,70
34A913016001	16,00	800	740	9002740626664	1	1	€ 67,26
34A913020001	20,00	800	740	9002740626671	1	1	€ 98,89

## Lengte-Longueur 1000/950 mm

Ref.	Ø mm	l1 mm	l2 mm	Bar code EAN13	Inh-Cont.		st/pcs
34A914010001	10,00	1000	950	9002740631217	1	1	€ 81,07
34A914012001	12,00	1000	950	9002740626688	1	1	€ 81,07
34A914014001	14,00	1000	950	9002740680857	1	1	€ 94,19
34A914016001	16,00	1000	950	9002740626695	1	1	€ 114,30
34A914018001	18,00	1000	950	9002740680864	1	1	€ 116,34
34A914020001	20,00	1000	950	9002740626701	1	1	€ 122,00
34A914025001	25,00	1000	950	9002740983330	1	1	€ 157,12

## Plastiek cassette -Casette plastic 5 st/pcs

Ref.	Ø mm	Bar code EAN13	Inh-Cont.		C st/pcs
34A807056801	5,0-6,0 x110mm-6,0-8,0-10,0x160mm	9002740335832	1	5	€ 17,55

Box Casette 10st/pcs →

## Metaal koffer -Coffre métallique 16 st/pcs

Ref.	L mm	Barcode		C st/pcs
34A005000161	Metaal koffer -Coffre métallique	9002740971917	1	€ 101,60
Ø 5,0 - 6,0	110	1	Beitels Burins	
Ø 6,0 - 8,0 - 10,0 - 12,0	160	1	Punt-Pointe	250 1
Ø 6,0 - 8,0 - 10,0	210	1	Plat-Plat	20 / 250 1
Ø 8,0 - 10,0 - 12,0 - 14,0	260	1	Breed-Large	40 / 250 1





**4 Vollhartmetallschneiden**

Kein Einhängen bei Armierungstreffern

**4 tungsten carbide cutting edges**

No hooking when hitting reinforcement

**4 filos de metal duro y macizo.**

No se engancha al impactar contra la armadura.



**Problemloses Durchbohren von Eisenarmierungen**

*Problem-free drilling through iron reinforcements*

*Perforación sin problemas de armaduras de hierro*



**Dübellängenindikator**

für exakte Bohrtiefe

**Dowel length indicator**

for exact drilling depth

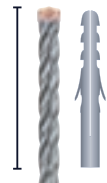

**Indicador de longitud del anclaje**

Para una profundidad de perforación exacta.

**Progressives Spiralendesign**

für schnellere Resultate

**Progressive spiral design**

for fast results

**Ranura diseñada de forma progresiva**

Para resultados más rápidos.

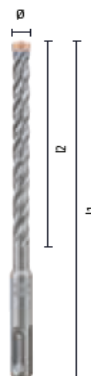
**Boren SDS+****FORCE X****Mèches SDS+****FORCE X****Lengte-Longueur 110/50 mm**

Ref.	Ø mm	l1 mm	l2 mm	Bar code EAN13	Inh-Cont.	
34A805005001	5,00	110	50	9002741265220	1	10
34A805005501	5,50	110	50	9002741265237	1	10
34A805006001	6,00	110	50	9002741265244	1	10
34A805007001	7,00	110	50	9002741265251	1	10
34A805008001	8,00	110	50	9002741265268	1	10
34A805010001	10,00	110	50	9002741265275	1	10

**Lengte-Longueur 160/100 mm**

Ref.	Ø mm	l1 mm	l2 mm	Bar code EAN13	Inh-Cont.	
34A815005001	5,00	160	100	9002741265282	1	10
34A815005501	5,50	160	100	9002741265299	1	10
34A815006001	6,00	160	100	9002741265305	1	10
34A815006501	6,50	160	100	9002741265312	1	10
34A815007001	7,00	160	100	9002741265329	1	10
34A815008001	8,00	160	100	9002741265336	1	10
34A815009001	9,00	160	100	9002741265343	1	10
34A815010001	10,00	160	100	9002741265350	1	10
34A815012001	12,00	160	100	9002741265367	1	10
34A815014001	14,00	160	100	9002741265374	1	10
34A815015001	15,00	160	100	9002741265381	1	10
34A815016001	16,00	160	100	9002741265398	1	10

**Lengte-Longueur 210/150 mm**

Ref.	Ø mm	l1 mm	l2 mm	Bar code EAN13	Inh-Cont.	
34A825005001	5,00	210	150	9002741265404	1	8
34A825006001	6,00	210	150	9002741265411	1	8
34A825006501	6,50	210	150	9002741265428	1	8
34A825008001	8,00	210	150	9002741265435	1	8
34A825010001	10,00	210	150	9002741265442	1	8
34A825012001	12,00	210	150	9002741265459	1	8
34A825014001	14,00	210	150	9002741265466	1	8
34A825016001	16,00	210	150	9002741265473	1	8



**Boren SDS+****Mèches SDS+****Lengte-Longueur 260/200 mm**

Ref.	Ø mm	l1 mm	l2 mm	Bar code EAN13	Inh-Cont.	
34A835006001	6,00	260	200	9002741265480	1	8
34A835006501	6,50	260	200	9002741265497	1	8
34A835008001	8,00	260	200	9002741265503	1	8
34A835009001	9,00	260	200	9002741265510	1	8
34A835010001	10,00	260	200	9002741265527	1	8
34A835012001	12,00	260	200	9002741265534	1	8
34A835014001	14,00	260	200	9002741265541	1	8
34A835015001	15,00	260	200	9002741265558	1	8
34A835016001	16,00	260	200	9002741265565	1	8
34A835018001	18,00	260	200	9002741277766	1	8
34A835020001	20,00	260	200	9002741277773	1	8
34A835022001	22,00	260	200	9002741277780	1	8
34A835024001	24,00	260	200	9002741277797	1	8
34A835025001	25,00	260	200	9002741277803	1	8

**Lengte-Longueur 310/250 mm**

Ref.	Ø mm	l1 mm	l2 mm	Bar code EAN13	Inh-Cont.	
34A845006001	6,00	310	250	9002741265572	1	8
34A845006501	6,50	310	250	9002741265589	1	8
34A845008001	8,00	310	250	9002741265596	1	8
34A845010001	10,00	310	250	9002741265602	1	8
34A845012001	12,00	310	250	9002741265619	1	8
34A845014001	14,00	310	250	9002741265626	1	8
34A845016001	16,00	310	250	9002741265633	1	8

**Lengte-Longueur 450/400 mm**

Ref.	Ø mm	l1 mm	l2 mm	Bar code EAN13	Inh-Cont.	
34A875008001	8,00	450	400	9002741265640	1	5
34A875010001	10,00	450	400	9002741265657	1	5
34A875012001	12,00	450	400	9002741265664	1	5
34A875014001	14,00	450	400	9002741265671	1	5
34A875016001	16,00	450	400	9002741265688	1	5
34A875018001	18,00	450	400	9002741278169	1	5
34A875020001	20,00	450	400	9002741277728	1	5
34A875022001	22,00	450	400	9002741277735	1	5
34A875024001	24,00	450	400	9002741277742	1	5
34A875025001	25,00	450	400	9002741277759	1	5
34A875028001	28,00	450	400	9002741281398	1	5
34A875030001	30,00	450	400	9002741281404	1	5
34A875032001	32,00	450	400	9002741281411	1	5



# Boren SDS+



# Mèches SDS+

## Lengte-Longueur 600/550 mm

Ref.	Ø mm	l1 mm	l2 mm	Bar code EAN13	Inh-Cont.		F st/pcs
34A905010001	10,00	600	550	9002741277209	1	5	€ 51,02
34A905012001	12,00	600	550	9002741277216	1	5	€ 58,31
34A905014001	14,00	600	550	9002741277223	1	5	€ 63,82
34A905016001	16,00	600	550	9002741277230	1	5	€ 76,34
34A905018001	18,00	600	550	9002741277247	1	5	€ 93,49
34A905020001	20,00	600	550	9002741277254	1	5	€ 102,05
34A905022001	22,00	600	550	9002741277261	1	5	€ 120,45



## Lengte-Longueur 1000/950 mm

Ref.	Ø mm	l1 mm	l2 mm	Bar code EAN13	Inh-Cont.		st/pcs
34A915010001	10,00	1000	950	9002741277278	1	1	€ 119,25
34A915012001	12,00	1000	950	9002741277285	1	1	€ 122,74
34A915014001	14,00	1000	950	9002741277292	1	1	€ 130,97
34A915016001	16,00	1000	950	9002741277315	1	1	€ 141,93



## Plastiek cassette -Casette plastic 5 st/pcs

Ref.	Ø mm	Bar code EAN13	Inh-Cont.		C st/pcs
34A805000051	5,0-6,0 x110mm-6,0-8,0-10,0x160mm	9002741276837	1	5	€ 21,95



Box Casette 10st/pcs →



## Metaal koffer -Coffre métallique 16 st/pcs

Ref.	L mm		C st/pcs		
34A005000161	Metaal koffer -Coffre métallique	Barcode 9002741276912	1	€ 112,50	
Ø 5,0 - 6,0	110	1	Beitels Burins		
Ø 6,0 - 8,0 - 10,0 - 12,0	160	1	Punt-Pointe	250	1
Ø 6,0 - 8,0 - 10,0	210	1	Plat-Plat	20 / 250	1
Ø 8,0 - 10,0 - 12,0 - 14,0	260	1	Breed-Large	40 / 250	1



## Adapter SDS Max >> SDS+ / Conversion SDS Max >> SDS+



### Conversie Adapter van SDS Max naar SDS+ Adaptateur de conversion SDS Max vers SDS+

Ref.	l1 mm	Bar code EAN13		F st/pcs
34A996000211	223	9002740624851	1	€ 115,35

## Beitels SDS+ Demolisher Plus Burins SDS+ Demolisher Plus



Ref.	l1 mm	Bar code EAN13	
34A987002511	250	9002741260805	1

NEW



Ref.	l1 mm	B-L	Bar code EAN13	
34A987002521	250	20	9002741260812	1

NEW



Ref.	l1 mm	B-L	Bar code EAN13	
34A987002531	250	40	9002741260829	1

NEW



# Beitels SDS+ / Burins SDS+

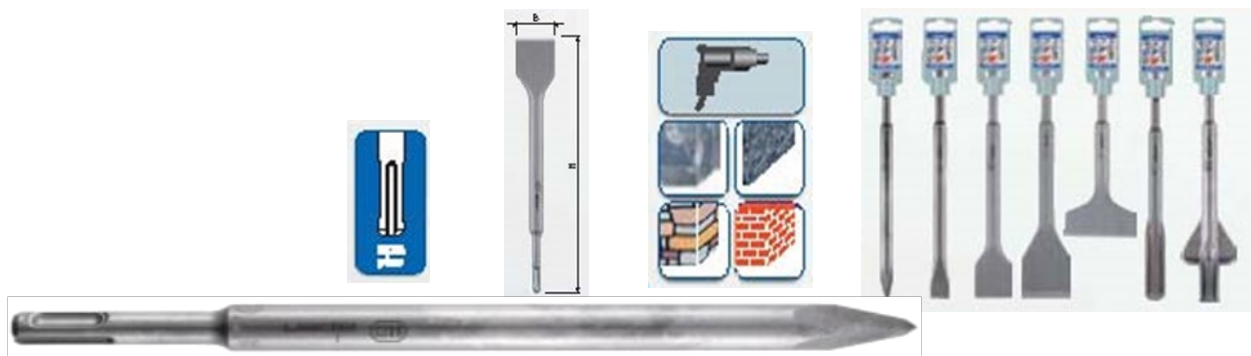

Ref.	l1 mm		Bar code EAN13		
34A980002501	250		9002740612537		1



Ref.	l1 mm	B/L mm	Bar code EAN13		
34A981002501	250	20	9002740612544		1



Ref.	l1 mm	B/L mm	Bar code EAN13		
34A982004251	250	40	9002740612551		1



Ref.	l1 mm	B/L mm	Bar code EAN13		
34A983005051	250	50	9002740008996		1



Ref.	l1 mm	B/L mm	Bar code EAN13		
34A985001651	165	75	9002741123476		1



Ref.	l1 mm	B/L mm	Bar code EAN13		
34A983002251	250	22	9002740612568		1



Ref.	l1 mm	B/L mm	Bar code EAN13		
34A984002251	250	22	9002740897064		1

# Kroon SDS+ Carbide

## Couronne SDS+ Carbide



### Complete kroon-Couronne complète SDS +

Ref.	Ø mm	l1 mm		Bar code EAN13		
34A897025001	25,00	85	65	9002741275366		1
34A897030001	30,00	85	65	9002741275373		1
34A897035001	35,00	85	65	9002741275380		1
34A897040001	40,00	85	65	9002740401377		1
34A897050001	50,00	85	65	9002741275397		1
34A897066001	66,00	85	65	9002740991168		1
34A897068001	68,00	85	65	9002740991175		1
34A897080001	80,00	85	65	9002740342182		1



Ref.		l1 mm				
34A898000951		85	M16	9002740581390		1
34A898001101	SDS +	110	M16	9002740581406		1
34A898002001	SDS +	220	M16	9002740581413		1



Ref.	Ø mm	l1 mm	l2 mm			
34A899008001	8,00	110	70	9002740581420		1

## DUST EXTRACTOR SHARP



### **Der neue 2 in 1 Bohrer:**

Bohren und Staubabsaugen in einem Schritt

### **The new 2-in-1 drill bit:**

Drilling and dust extraction in a single step

### **La nueva broca 2 en 1:**

Perforar y aspirar el polvo en un paso

### **Saubere, staubfreie Bohrlöcher**

für das Setzen chemischer Dübel

### **Clean, dust-free drill holes**

for inserting chemical anchors

### **Orificios limpios sin polvo**

para fijar anclajes químicos

### **Perfekt**

für Arbeiten in kritischen Bereichen,  
die staubfrei gehalten werden müssen

### **Perfect**

for working in critical areas  
that must be kept free of dust

### **Perfecto**

para trabajar en áreas sensibles,  
que no deben ser contaminados con polvo

### **Erspart lästige Reinigung der Umgebung**

Saves annoying cleaning of the surroundings

Evita la limpieza fastidiosa del ambiente

### **Schützt den Anwender**

vor gesundheitlichen Belastungen

### **Protects the user**

from damage to health

### **Protege al usuario**

de problemas de salud

### **Entfernt den Bohrstaub**

bereits bei der Entstehung am Bohrkopf!

### **Removes the drilling dust**

where it originates at the drill tip!

Elimina el polvo ya en el momento de su  
formación en la punta de la broca

# SDS+ Afzuigboor

## Foret d'Aspiration SDS+

De SDS + hamerboor met afzuiging met weinig slijtage en onderhoud en zeer lange levensduur. Krachtige boor voor het boren in beton, natuursteen en Metselwerk.

Foret marteau SDS + pour le forage par aspiration, avec peu d'usure et très peu d'entretien et une longue durée de vie. Foret haute performance pour perçage au marteau dans le béton, la pierre naturelle et la maçonnerie.

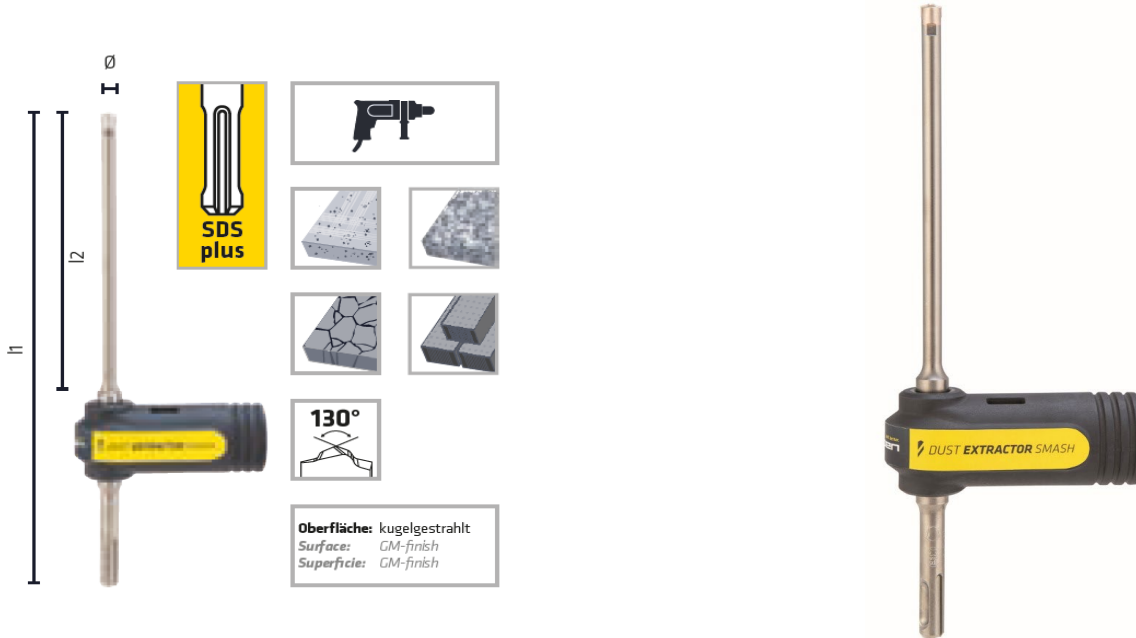

Oberfläche: kugelgestraht  
Surface: GM-finish  
Superficie: GM-finish

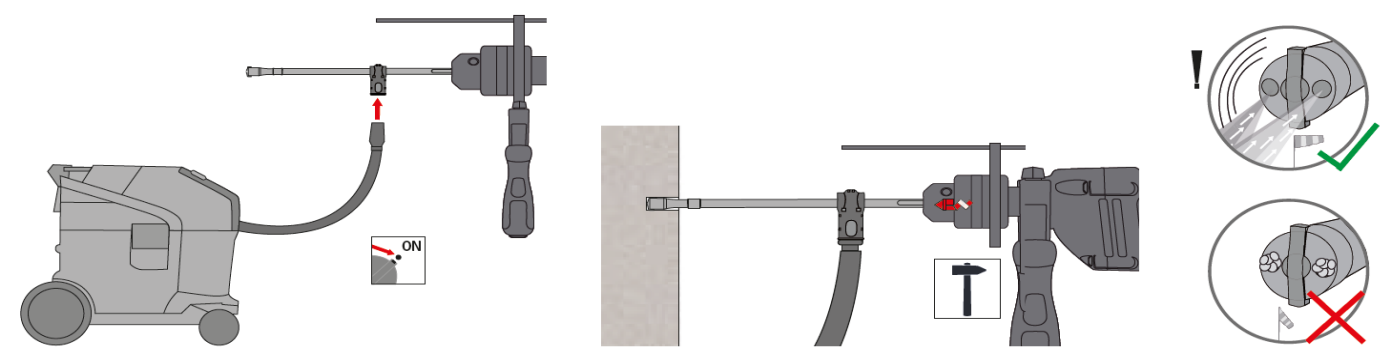

Ref.	Ø mm	l1 mm		Bar code EAN13		
34A580006001	6,00	220	100	9002741278435		1
34A580008001	8,00	270	150	9002741278312		1
34A580010001	10,00	270	150	9002741278305		1
34A580012001	12,00	320	200	9002741278299		1
34A580014001	14,00	370	250	9002741278282		1
34A580016001	16,00	370	250	9002741278275		1



 **PROFI DACH**



**Hart**

Auch die härtesten Dachziegel können nicht widerstehen

**Hard**

Even the hardest roof tiles cannot resist

**Resistente**

Ni siquiera las tejas más duras se pueden resistir



**Exakt**

durch präzisionsgeschliffene Spiralnuten

**Precise**

due to precision-ground spiral flutes



**Passt. Sitzt. Hält.**

Durch genormtes Schaftprofil passend für jede Akkumaschine

**Fits. Sits. Holds.**

With standardised shank profile fitting every cordless drill

**Apta. Encaja. Resistente.**

Gracias al perfil de eje normativo es apta para todas las máquinas con batería

**Profi DACH**

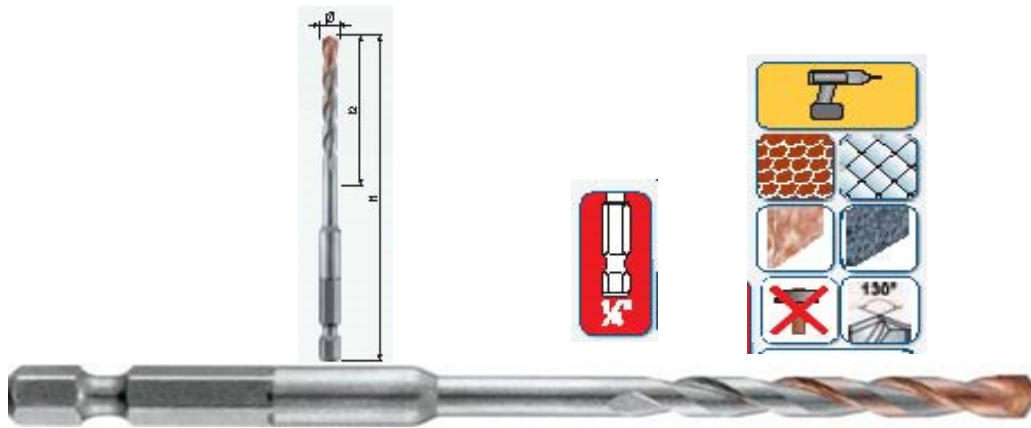

**Speciaal boor voor pannen,eternit,ceramic,marber,graniet,lesteen.**  
**Mèche spécial pour tuiles,eternit,céramic,marbre,granit,ardoise .**

Ref.	Ø mm	l1 mm	l2 mm	Bar code EAN13	Inh-Cont.	
34A252003501	3,50	100	39	9002741104581	1	10
34A252004001	4,00	100	39	9002741104567	1	10
34A252005001	5,00	100	39	9002741104628	1	10
34A252006001	6,00	100	54	9002741104543	1	10

Ref.	Ø mm	l1 mm	l2 mm	Bar code EAN13	Inh-Cont.	
34A253003501	3,50	100	39	9002741121724		10
34A253004001	4,00	100	39	9002741121731		10
34A253005001	5,00	100	39	9002741121748		10
34A253006001	6,00	100	54	9002741173235		10



**Houder 1/4 / Tête 1/4**

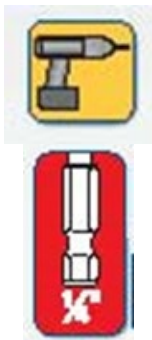

Ref.	l1 mm	Bar code EAN13	Inh-Cont.	
34A705030711	79	9002741124862	1	1

# Hout boor Type Lewis

## Mèche bois Type Lewis

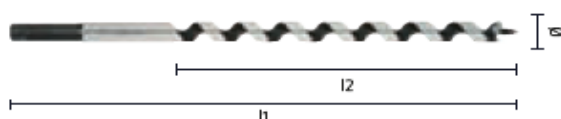
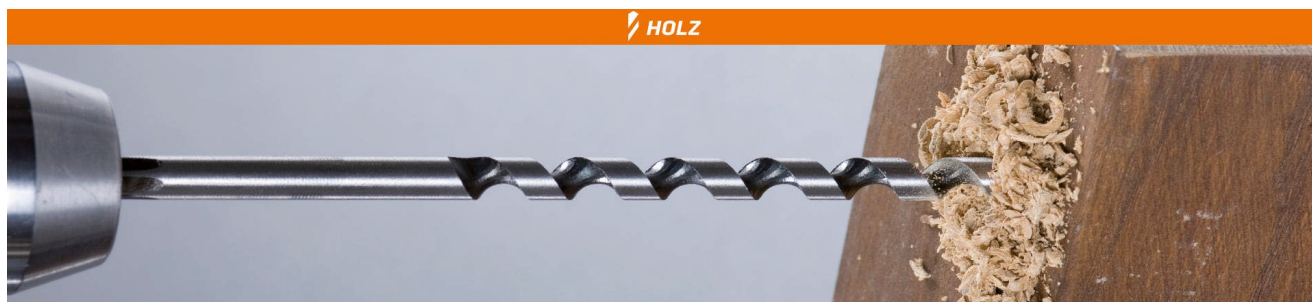

Ref.	Ø mm	l1 mm	l2 mm	Bar code EAN13	Inh-Cont.	
34A216006001	6,00	235	160	9002740584551	1	1
34A216008001	8,00	235	160	9002740219507	1	1
34A216010001	10,00	235	160	9002740219514	1	1
34A216012001	12,00	235	160	9002740219521	1	1
34A216014001	14,00	235	160	9002740219538	1	1
34A216015001	15,00	235	160	9002740691518	1	1
34A216016001	16,00	235	160	9002740219545	1	1
34A216018001	18,00	235	160	9002740219552	1	1
34A216020001	20,00	235	160	9002740219569	1	1
34A216022001	22,00	235	160	9002740672913	1	1
34A216024001	24,00	235	160	9002740672920	1	1
34A216025001	25,00	235	160	9002740672937	1	1
34A216026001	26,00	235	160	9002740672944	1	1
34A216028001	28,00	235	160	9002740672951	1	1
34A216030001	30,00	235	160	9002740672968	1	1
34A216032001	32,00	235	160	9002740672975	1	1

Ref.	Ø mm	l1 mm	l2 mm	Bar code EAN13	Inh-Cont.	
34A226008001	8,00	460	380	9002740583684	1	1
34A226010001	10,00	460	380	9002740219613	1	1
34A226012001	12,00	460	380	9002740219620	1	1
34A226014001	14,00	460	380	9002740219644	1	1
34A226016001	16,00	460	380	9002740219651	1	1
34A226018001	18,00	460	380	9002740219668	1	1
34A226020001	20,00	460	380	9002740219675	1	1
34A226022001	22,00	460	380	9002740581437	1	1
34A226024001	24,00	460	380	9002740581444	1	1
34A226025001	25,00	460	380	9002741112715	1	1
34A226026001	26,00	460	380	9002740672982	1	1
34A226028001	28,00	460	380	9002740672999	1	1
34A226030001	30,00	460	380	9002740673002	1	1
34A226032001	32,00	460	380	9002740673019	1	1



## Plat hout boor / Mèche bois platte

Ref.	Ø mm	l1 mm		Bar code EAN13	Inh-Cont.	
34A237006001	6,00	152		9002740907596	1	10
34A237008001	8,00	152		9002740907602	1	10
34A237010001	10,00	152		9002740907619	1	10
34A237012001	12,00	152		9002740907626	1	10
34A237013001	13,00	152		9002740981084	1	10
34A237014001	14,00	152		9002740907633	1	10
34A237016001	16,00	152		9002740907640	1	10
34A237017000	17,00	152		9002740981091	1	10
34A237018001	18,00	152		9002740907657	1	10
34A237019001	19,00	152		9002740981107	1	10
34A237020001	20,00	152		9002740907664	1	10
34A237022001	22,00	152		9002740907671	1	10
34A237024001	24,00	152		9002740907688	1	10
34A237025000	25,00	152		9002740981114	1	10
34A237026001	26,00	152		9002741093106	1	10
34A237028001	28,00	152		9002740981121	1	10
34A237030001	30,00	152		9002740907695	1	10
34A237032001	32,00	152		9002740907701	1	10
34A237035001	35,00	152		9002740907718	1	10
34A237038001	38,00	152		9002740907725	1	10
34A237040001	40,00	152		9002740981138	1	10



## Verlengstuk voor plat hout boor L.300mm

## Ralonge pour mèche bois platte L.300mm



Ref.				Bar code EAN13	Inh-Cont.	
34A237099991				9002741023721	1	10

Ref.	Cassette 5 stuks-pièces			Bar code EAN13	Inh-Cont.	
34A237000151	Ø 16,18,20,22,24 mm			9002741202997	1	5





## HSS Cobalt Hout-Bois Resistant 650° C

Ref.	Ø mm	l1 mm	l2 mm	Bar code EAN13	Inh-Cont.	
34A633003001	3,00	61	33	9002741181001	1	10
34A633004001	4,00	75	43	9002741181018	1	10
34A633005001	5,00	86	52	9002741181025	1	10
34A633006001	6,00	93	57	9002741181032	1	10
34A633007001	7,00	109	69	9002741181049	1	10
34A633008001	8,00	117	75	9002741181056	1	10
34A633009001	9,00	125	81	9002741181063	1	10
34A633010001	10,00	133	87	9002741181070	1	10
34A633011001	11,00	142	94	9002741181087	1	10
34A633012001	12,00	151	101	9002741181094	1	10
34A633014001	14,00	160	108	9002741181100	1	10
34A633016001	16,00	178	120	9002741181117	1	10
34A633018001	18,00	178	120	9002741181124	1	10
34A633020001	20,00	178	120	9002741181131	1	10



Ref.	Cassette 5 stuks-pièces	Bar code EAN13	Inh-Cont.	
34A633000051	Ø4,5,6,8,10 mm	9002741197712	1	5

## HSS Hout-Bois 250°C

Ref.	Ø mm	l1 mm	l2 mm	Bar code EAN13		
34A616003001	3,00	61	33	9002740220299	1	10
34A616004001	4,00	75	43	9002740220305	1	10
34A616005001	5,00	86	52	9002740220312	1	10
34A616006001	6,00	93	57	9002740220329	1	10
34A616007001	7,00	109	69	9002740220336	1	10
34A616008001	8,00	117	75	9002740220343	1	10
34A616009001	9,00	125	81	9002740221999	1	10
34A616010001	10,00	133	87	9002740222002	1	10
34A616011001	11,00	142	94	9002740222019	1	10
34A616012001	12,00	151	101	9002740222026	1	10
34A616013001	13,00	151	101	9002740222033	1	10
34A616014001	14,00	160	108	9002740222040	1	8
34A616015001	15,00	169	114	9002740222057	1	8
34A616016001	16,00	178	120	9002740222064	1	8
34A616018001	18,00	178	120	9002740222088	1	8
34A616020001	20,00	178	120	9002740222095	1	8



Ref.	Cassette 8 stuks-pièces	Bar code EAN13	Inh-Cont.	
34A006000921	Ø 3→10 mm x 1 mm	9002740218197	1	1

 **LONG LIFE**



**Optimale Fixierung**  
der Hartmetallplatte im Grundkörper

*Optimum attachement*  
of the carbide tip in the core

*Fijación óptima*  
de la placa de metal duro en el cuerpo  
base

**Profil gefräst**  
wie bei SDS-Bohrern

*Profile milled*  
as with SDS bits

*Perfil fresado*  
como para las brocas SDS

**Stabiler Grundkörper**  
aus Werkzeugstahl

*Robust core*  
made of tool steels

*Cuerpo base robusto*  
de acero para herramientas

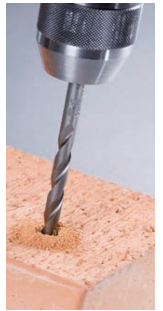
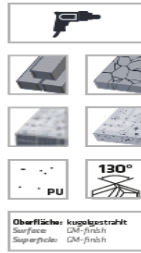

**Long Life****TUNGSTEN CARBIDE**

Ref.	Ø mm	l1 mm	l2 mm	Bar code EAN13	Inh-Cont.	
34A117003001	3,00	60	30	9002740224709	1	10
34A117004001	4,00	75	39	9002740224723	1	10
34A117005001	5,00	85	39	9002740224747	1	10
34A117005501	5,50	85	39	9002740224754	1	10
34A117006001	6,00	100	54	9002740224761	1	10
34A117006501	6,50	100	54	9002740224778	1	10
34A117007001	7,00	100	54	9002740224785	1	10
34A117008001	8,00	120	80	9002740224792	1	10
34A117009001	9,00	120	80	9002740224815	1	10
34A117010001	10,00	120	80	9002740224822	1	10
34A117011001	11,00	150	90	9002740224839	1	10
34A117012001	12,00	150	90	9002740224846	1	10
34A117013001	13,00	150	90	9002740224853	1	10
34A117014001	14,00	150	90	9002740224860	1	10
34A117015001	15,00	150	90	9002740224877	1	10
34A117016001	16,00	150	90	9002740224884	1	10
34A117018001	18,00	160	100	9002740224907	1	10
34A117020001	20,00	160	100	9002740224914	1	10
34A117022001	22,00	160	100	9002740224921	1	5
34A117024001	24,00	160	100	9002740224938	1	5

**Lengte-Longueur 150/90 mm**

Ref.	Ø mm	l1 mm	l2 mm	Bar code EAN13	Inh-Cont.	
34A718005001	5,00	150	90	9002740342106	1	10
34A718005501	5,50	150	90	9002740342113	1	10
34A718006001	6,00	150	90	9002740342120	1	10
34A718006501	6,50	150	90	9002740342137	1	10
34A718007001	7,00	150	90	9002740342144	1	10
34A718008001	8,00	150	90	9002740342151	1	10
34A718010001	10,00	150	90	9002740342168	1	10

**Lengte-Longueur 200/140 mm**

Ref.	Ø mm	l1 mm	l2 mm	Bar code EAN13	Inh-Cont.	
34A367006001	6,00	200	140	9002740230953	1	8
34A367008001	8,00	200	140	9002740230960	1	8
34A367010001	10,00	200	140	9002740230977	1	8
34A367012001	12,00	200	140	9002740230984	1	8
34A367014001	14,00	200	140	9002740230991	1	8
34A367016001	16,00	200	140	9002740898634	1	8



### Lengte-Longueur 300/220 mm

Ref.	Ø mm	l1 mm	l2 mm	Bar code EAN13	Inh-Cont.	
34A327006001	6,00	300	220	9002740674900	1	5
34A327008001	8,00	300	220	9002740674917	1	5
34A327010001	10,00	300	220	9002740674924	1	5
34A327012001	12,00	300	220	9002740674931	1	5
34A327014001	14,00	300	220	9002740674948	1	5
34A327016001	16,00	300	220	9002740674955	1	5
34A327018001	18,00	300	220	9002740674962	1	5
34A327020001	20,00	300	220	9002740674979	1	5
34A327025001	25,00	300	220	9002740674986	1	5

### Lengte-Longueur 400/300 mm

Ref.	Ø mm	l1 mm	l2 mm	Bar code EAN13	Inh-Cont.	
34A517006001	6,00	400	300	9002740231400	1	5
34A517006501	6,50	400	300	9002740382171	1	5
34A517008001	8,00	400	300	9002740231431	1	5
34A517010001	10,00	400	300	9002740231448	1	5
34A517012001	12,00	400	300	9002740231455	1	5
34A517013001	13,00	400	300	9002740231462	1	5
34A517014001	14,00	400	300	9002740231479	1	5
34A517016001	16,00	400	300	9002740231486	1	5
34A517018001	18,00	400	300	9002740231493	1	5
34A517020001	20,00	400	300	9002740231509	1	5
34A517022001	22,00	400	300	9002740231516	1	5
34A517024001	24,00	400	300	9002740231523	1	5
34A517025001	25,00	400	300	9002740231530	1	5

### Lengte-Longueur 600/500 mm

Ref.	Ø mm	l1 mm	l2 mm	Bar code EAN13	Inh-Cont.	
34A617008001	8,00	600	500	9002740232322	1	5
34A617010001	10,00	600	500	9002740232339	1	5
34A617012001	12,00	600	500	9002740232346	1	5
34A617014001	14,00	600	500	9002740232360	1	5
34A617016001	16,00	600	500	9002740232377	1	5
34A617018001	18,00	600	500	9002740232384	1	5
34A617020001	20,00	600	500	9002740232391	1	5

